

ASSEMBLY INSTRUCTION

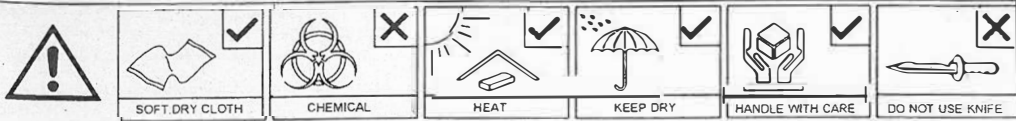

HARDWARE	A 16MM CB SCREW M3.5X16MM 1X20	B 38MM CB SCREW M4X38MM 1X4	C NAIL 5/8 1X16	D D1 D2 D3 3.5 KG MAGNET (1 HOLE) 2 SETS	E SHELF SUPPORT 1X8	F DOOR SUPPORT SPRING 1X2	G G1 G2 MAS R4 1X1 MAS L4 1X1	H ROUND PLASTIC LEG 1X4	I I1 I2 MINIFIX 5654+5546 4 SETS	J L-KEY 1X1	K QUICKFIT CAP 1X4
----------	---	--	------------------------------	--	----------------------------------	--	--	--------------------------------------	---	--------------------------	---------------------------------

PART LIST

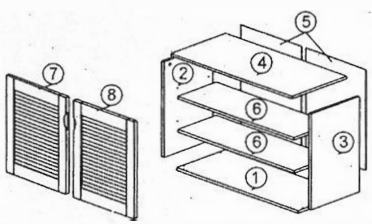

STEP 1

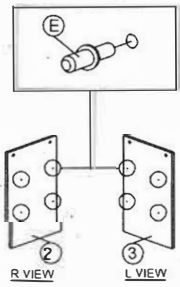

STEP 2

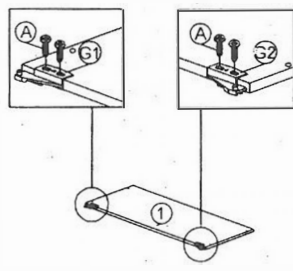

STEP 3

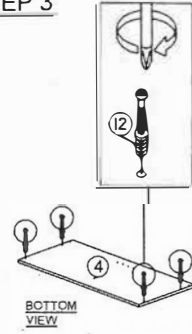

STEP 4

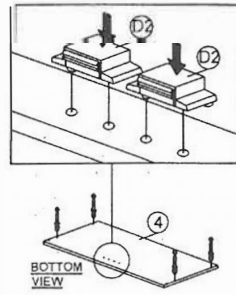

STEP 5

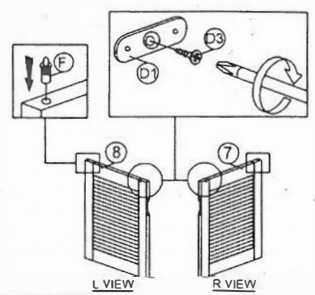

STEP 6

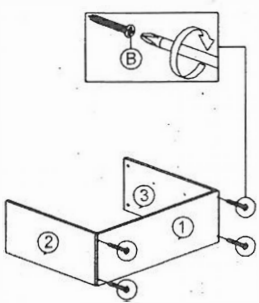

STEP 7

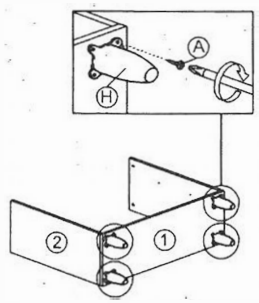

STEP 8

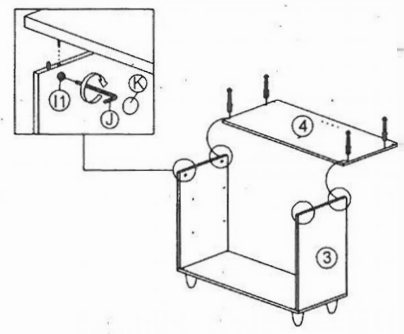

COMPLETED

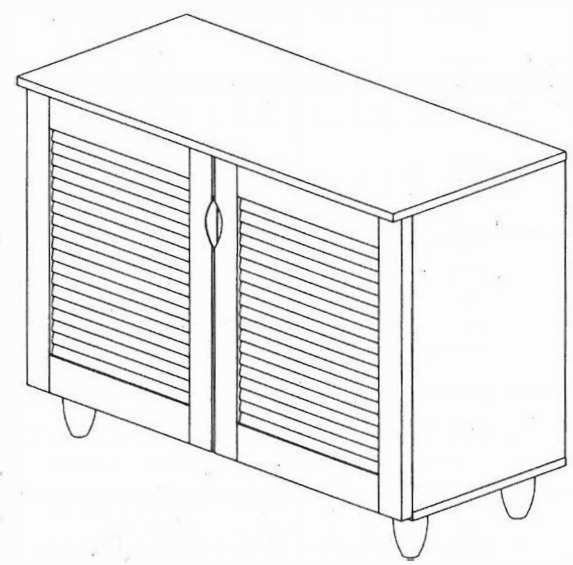

STEP 9

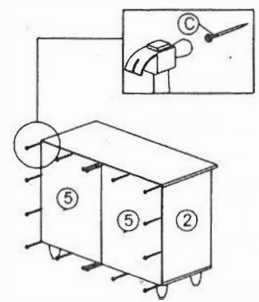

STEP 10

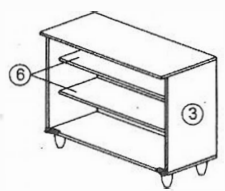

STEP 11

